

TABLE OF CONTENTS

◆ Introduction.....	01
◆ Features of CUG SERIES	02
◆ Precaution.....	03
◆ Installation.....	03
◆ Cable Management.....	04
◆ Cable Illustration.....	04
◆ Electric Specification.....	08
◆ Physical Dimension.....	08
◆ Connectors Description and Illustration.....	09
◆ Product-Related Specification.....	10
◆ Safety Approval.....	10
◆ Protection Function.....	11
◆ Trouble Shooting.....	12

English Version

>>> Introduction

Thank you very much for choosing Coolmax product. This user manual includes a brief description of the specification and technical detail of power supplies which will give you a better idea of its performance characteristic. Mechanical drawing and connector instruction will help you know your power supply from its appearance. Installation instruction should help you install the unit into your case in an adequate way. Precaution will keep you informed important information and safety requirement with this unit. And Trouble Shooting shall answer the question you may have during its operation.

Shall you have any suggestion or comments or you want to know more about Coolmax products and company, please access our web site www.coolmaxusa.com or send you e-mail to support@coolmaxusa.com . We appreciate your kindly feedback and you will receive the prompt and satisfactory response from our customer service team.

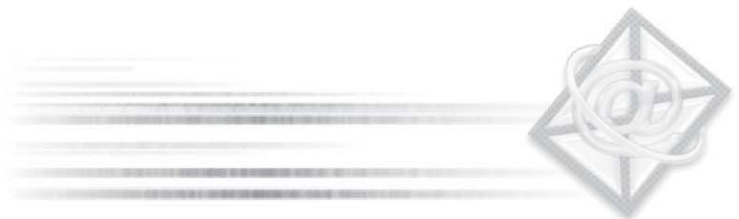

>>> Features of CUG SERIES

► **Powerful & High-Efficiency Performance** Advanced technology for maximize the performance



Triple +12V Output Rails
Three independent +12V output rails ensure safe and stable system operation under heavy operation.



Advanced Double Forward Circuit and Double-Layer PCB
Brings more reliable, high efficiency and powerful power supply.



Active Power Factor Correction
Corrects power factor from typical 50% to theory-ideal 99%. Environment friendly technology reduces the loss of electricity and save your money on facility bill.



Super High Efficiency: Maximum 84%
Higher reliability, thermal control and environmental friendliness through increased efficiency. With advanced circuit design and well-chosen components, CUG SERIES provide typical 80% efficiency which is much better than the average 70% in the market.

► **Total Silent Solution** Silent efforts from PSU to system



Ultimate balance between cooling and noise level
Extreme low noise level using Smart Fan Control Circuit based on our Automatic Temperature Sensor.
Increased silence, extended fan life and more reliable performance by eliminating unnecessary high RPM.



Honey Comb Structure with best ventilation
Optimum structure for best ventilation and maximize air flow to solve potential thermal and noise problem.
Reduce the air resistance to minimum.



Reliable 12cm Fan
Provides same airflow with lower RPM and noise level than 8cm fan.

► **Smart Cable Management** Arrange the cables smartly and neatly



All output cables with Nylon sleeving
Cable sleeving avoids cable clutter, allows neat and easy installation for an improved airflow.



Cable Management
Cable Management enables you to freely select wiring harnesses as you need.
Specific color connectors and infixed socket with sticker design can assist in the installation.



Flexible Connector & System Design
Supports various systems with flexible (20+4) pin Main Power & (4+4) pin +12V connectors.



Patented Easy Swap Connector
Quick and Easy installation.



Dual PCI-Express Power Connectors fully support SLI & Cross-Fire system
CUG SERIES provide dual 6pin PCI-E power connector with sufficient and stable current to fully support SLI & Cross-Fire Systems.

www.coolmaxusa.com

>>> Precaution

- CUG SERIES are designed with Free AC Input which enable it be used in any territory with different AC input voltage (115V~230V)
- Please do not log out the AC power line when the Power Supply is in use, even in a flash quick manner will cause damage to the components.
- Please do not store the switching Power Supply in high humid temperature place, or to be used in such condition.
- When put an ATX type switching Power Supply in testing condition (Log in alone/ not installed in a PC case), must connect to a "Load"(A hard Drive for instance), then the Switching Power Supply can be turned on(Fan start to rotate) and DC power output will be in operation.
- Unless authorized personnel, please do not unscrew the power case for any purpose.

>>> Installation

- Disconnect the power cord from your old power supply.
- Follow your computer case manual and disassemble the case.
- Disconnect all the power Connectors from the motherboard and from the peripheral devices such as case fans, hard drives, floppy drives. Etc.
- Remove the existing power supply from your computer case and replace it with the Coolmax power supply.
- Connect the power Connectors to the motherboard and peripheral drives (**please refer to page 04**).
- Close the computer case.
Connect the power cord to the Coolmax power supply.

>>> Cable Management

CUG SERIES enable you to freely select wiring harnesses as you need. Specific color connectors and infixed socket with sticker design pasted on the power supply unit can assist in the installation. Concurrently, Coolmax Cable Management can lower down confusion inside your PC case for improving air circumrotation.

>>> Cable Illustration

Cable Length		
No.	A	B
(mm)	550	200

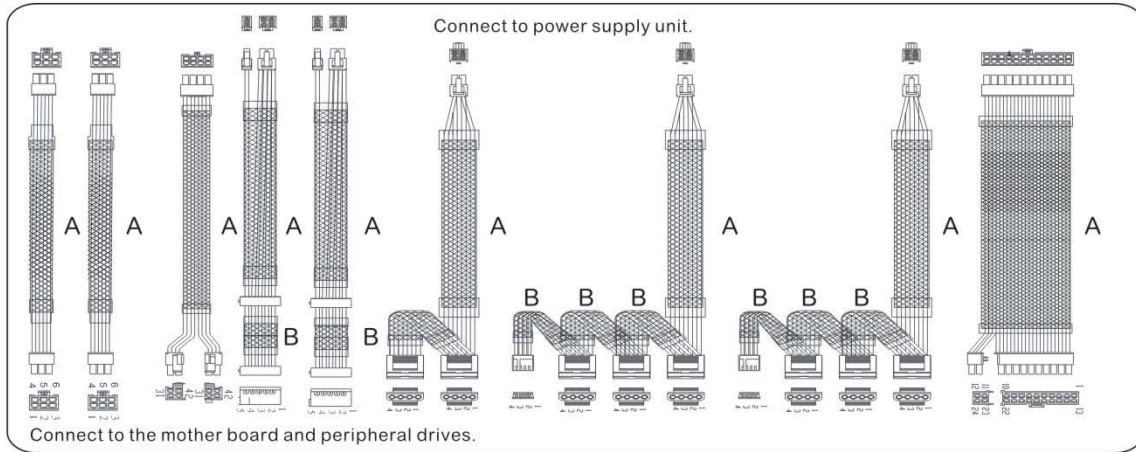

Upon one side of power supply unit with cable management, you can detect the sets of wires extended from the PSU inside and you can find the infixed sockets on the side of PSU. Each socket is for each connector. These sets of wires with connectors include:

- a. One set of wires with the)20+4 pin(Main Power Connector at one ends for motherboard and a 24-pin PSU blue connector at another end. This)20+4 pin(adapter could meet the requirement of motherboard you choose.

Qty	1
Connector Color	

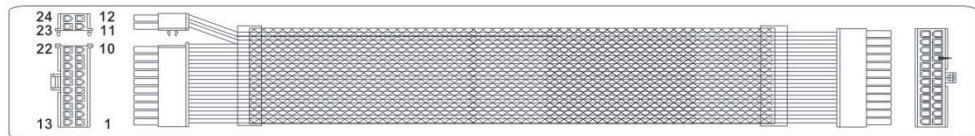

- b. One set of wires with (4+4 pin) +12V Power Connector at one end and an 8-pin +12V PSU blue connector at another end. These All-in-one Main power Connector to M/B (20+4) pin + (4+4) pin supports PC, IPC, server and dual CPU systems.

Qty	1
Connector Color	

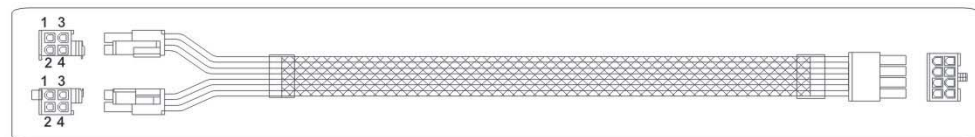

c. Two sets of wires with a 6-pin PCI-Express graphic card connector at one end and a 6-pin power supply unit red connector at another end.

Qty	2
Connector Color	

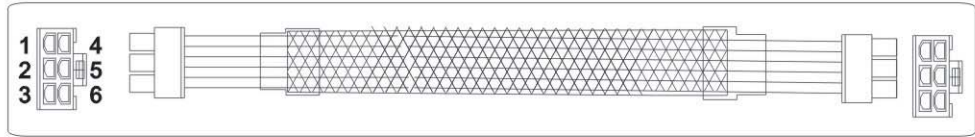

d. Two sets of wires with a 4-pin PSU black connector at one end and three standard 4-pin peripheral and one floppy power connectors at others ends

Qty	2
Connector Color	

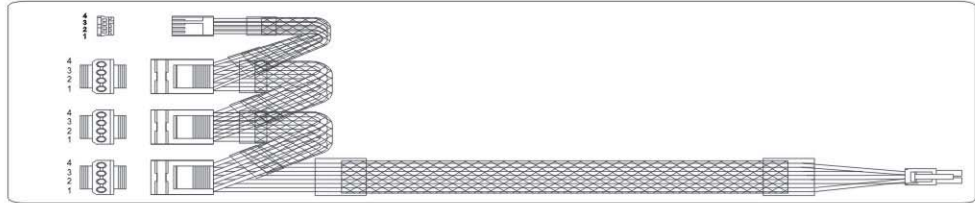

e. One set of wires with a 4-pin PSU black connector at one end and two standard 4-pin peripheral connectors at others end.

Qty	1
Connector Color	

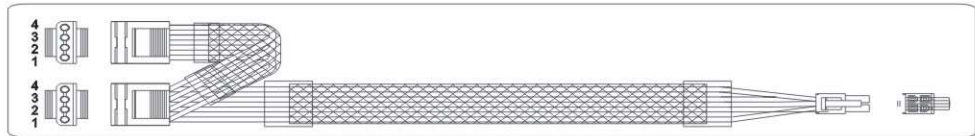

f. Two sets of wires with two Serial ATA connectors at the ends and the (4+2 pin) PSU black connectors at the other end. [Remark] the s-ATA connectors contain the 3.3V output so that you can set latest generation s-ata devices.

Qty	2
Connector Color	

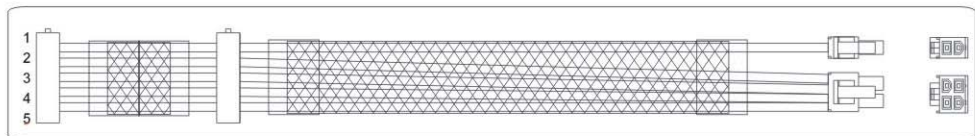

All the right side connectors above are installed to the side of infixed sockets by PSU. Moreover, please refer to the configuration below and correspond the letters to the above a, b, c, d, e, f for install wiring harnesses exactly.

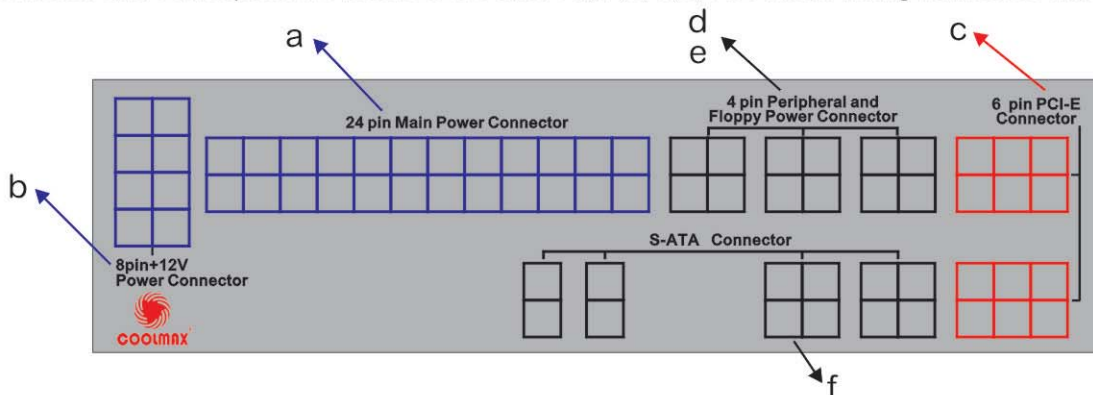

>>> Electric Specification

INPUT	Fan Type	12cm Fan
	Model	CUG-700B
	Voltage	115V~230V
	Frequency	47~63Hz
	Current	10A
OUTPUT	Efficiency	Typical 80%
	P.F.	Typical 0.99
	DC Voltage	DC Current (Min/Max)
	+5V	30A
	+3.3V	24A
	+12V1	16A
	+12V2	16A
	+12V3	15A
	+12V4	12A
	-12V	0.5A
	+5vsb	3A
	+5V&+3.3V	180W
	Total Output	750W

>>> Physical Dimension

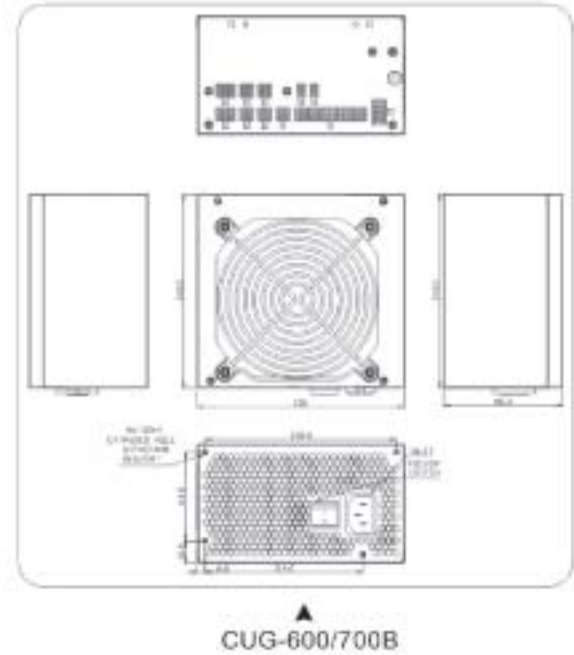

>>> Connectors Description and Illustration

Main Power Connector

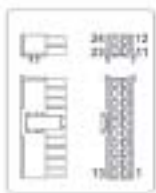

Voltage	Color	Pin	Wire	Color	Wire
+3.3 V	Orange	1	13	Orange	+3.3 V
+5 V	Green	2	14	Blue	-12 V
COM	Black	3	12	Black	COM
+5 V	Red	4	16	Green	PS-ON
COM	Black	5	17	Black	COM
+5 V	Blue	6	18	Black	COM
COM	Black	7	19	Black	COM
PS-ON	Grey	8	20	Red	PS
+5 VSB	Purple	9	21	Red	+5 V
+12 V	Yellow	10	22	Red	+5 V
+12 V	Yellow	11	23	Red	+5 V
+12 V	Orange	12	24	Black	COM

PCI Express Connector (5 pin)

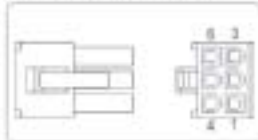

Color	Signal	Pin
Yellow	3.3VDC	1
Yellow	3.3VDC	2
Yellow	3.3VDC	3
Black	COM	4
Black	COM	5
Black	COM	6

Peripheral Connector (4 pin)

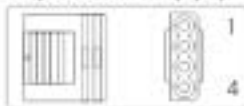

Color	Signal	Pin
Yellow	+12V/DC	1
Black	COM	2
Black	COM	3
Red	+5VDC	4

+12V Connector (4+4 pin)



Color	Signal	Pin
Black	COM	1
Black	COM	2
Black	COM	3
Black	COM	4
Yellow	+12VDC	5
Yellow	+12VDC	6
Yellow	+12VDC	7
Yellow	+12VDC	8

Floppy Disk Connector (4 pin)



Color	Signal	Pin
Red	+5VDC	1
Black	COM	2
Black	COM	3
Yellow	+12V/DC	4

Serial ATA Power Connector

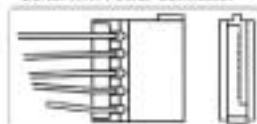

Color	Signal	Pin
Yellow	+12V/DC	1
Black	COM	2
Red	+5VDC	3
Black	COM	4
Orange	+3.3 VDC	5

>>> Product -Related Specification

► Temperature

Storage ambient : 0°C~50°C

Operating ambient : -40°C~60°C

► Humidity

Storage : 20°C~90°C : Operation : 20%~95%

► Altitude

The power supply can operate normally at any attitude between 0~8000 ft

>>> Safety Approval

Coolmax switching power supply has been certified to comply with multiple safety and EMI standards.

► Safety



► EMI



► MTBF(Mean Time Between Failure)

The MTBF of the power supply is calculated by utilizing the quality factors listed in Part-Stress Analysis method of MIL-HDBK-217F

The calculated MTBF of Coolmax switching power supply is greater than 100,000 hours under the following conditions:

70% full loading, 220VAC/50Hz input, 25°C ambient.

>>> Protection function

All the Coolmax products are designed with comprehensive protection features to safeguard the power supply and system.

Notice

If the power supply latches into shut down stage (when protection function is in effect as defined below), the power supply shall return to normal operation only after the fault has been removed and PS-on has been cycled off/on for a minimum of time for 1 second or remove AC power from the power supply then re-applied.

► Over/Under Voltage Protection(OVP/UVP)

When the output voltage exceeds the spec defined below, the power supply shall be latched into the status of shutdown.

DC OUTPUT	UVP (Min)	OVP(Max)
+5V	3.9V	7.0V
+3.3V	2.8V	4.3V
+12V	8.0V	15.6V

► Over Current Protection(OCP)

Overload current applied to each tested output rail will cause output trip before they reach or exceed 110% ~ 150% for testing purposes. Over load current shall be ramped at a minimum rate of 10A/s starting from full load.

