

TABLE OF CONTENTS

◆ Introduction	01
◆ Features of RockSolid Series	02
◆ Precaution	03
◆ Installation	03
◆ High Power Cable Management	04
◆ High Power Cable Illustration	04
◆ Electric Specification	09
◆ Physical Dimension	10
◆ Connectors Description and Illustration	11
◆ Product-Related Specification	12
◆ Safety Approval	12
◆ Protection Function	13
◆ Trouble Shooting	14

English Version

>>> Introduction

Thank you very much for choosing high-quality Coolmax product. This user manual includes a brief description and technical detail of power supplies which will give you a better idea of its performance characteristic. Mechanical drawing and connector instruction will help you know your power supply from its appearance. Installation instruction should help you install the unit into your case in an adequate way. Precaution will keep you informed important information and safety requirement with this unit. And Trouble Shooting shall answer the question you may have during its operation.

Shall you have any suggestion or comments or

you want to know more about Coolmax products and company, please access our web site www.coolmaxusa.com or send you e-mail to support@coolmaxusa.com. We appreciate your kindly feedback and you will receive the prompt and satisfactory response from our customer service team.



>>> Features of RockSolid Series

► **Powerful & High-Efficiency Performance** Advanced technology for maximize the performance



Quad, Independent +12V Output Rails
Stable and accurate output voltage by Dual Main Transformer.



Advanced Double Forward Circuit and Double-Layer PCB
Brings more reliable, high efficiency and powerful power supply.



Active Power Factor Correction
Corrects power factor from typical 50% to theoretical 99% .
Environment friendly technology reduces the loss of electricity and save your money on facility bill.



80% PLUS Efficiency Standard Compliant
Reach 80% efficiency at 20% to 100% load condition.

► **Total Silent Solution** Silent efforts from PSU to system



Ultimate balance between cooling and noise level
Extreme low noise level using High Power's Smart Fan Control Circuit based on our Automatic Temperature Sensor.
Increased silence, extended fan life and more reliable performance by eliminating unnecessary high RPM.



Silent & Durable 13.5+8cm Fan Combination Structure
Physical size: 210 x 150 x 86mm



Fan Delay-Off Feature
Allows PSU fans to continue cooling after shutdown till system temperature is < 50°C, providing advanced cooling and extended hardware/component lifetime.

► **Smart Cable Management** Arrange the cables smartly and neatly



All Cables are sleeved with Nylon netting
Neat and easy installation available.



Modular Cable Mechanism
Freely select the cables you need.



Flexible Connector & System Design
Supports various systems with flexible(20+4)pin Main Power & (4+4)pin +12V connectors.



Patented Easy Swap Connector
Quick and Easy installation.

www.coolmaxusa.com

>>> Precaution

- Coolmax Rocksolid series is designed with Free AC Input which enable it be used in any territory with different AC input voltage (110V~240V)
- Please do not log out the AC power line when the Power Supply is in use, even in a flash quick manner will cause damage to the components.
- Please do not store the switching Power Supply in high humid temperature place, or to be used in such condition.
- When put an ATX type switching Power Supply in testing condition (Log in alone/ not installed in a PC case), must connect to a "Load" (A hard Drive for instance), then the Switching Power Supply can be turned on(Fan start to rotate) and DC power output will be in operation.
- Unless authorized personnel, please do not unscrew the power case for any purpose.

>>> Installation

- Disconnect the power cord from your old power supply.
 - Follow your computer case manual and disassemble the case.
 - Disconnect all the power Connectors from the motherboard and from the peripheral devices such as case fans, hard drives, floppy drives. Etc.
 - Remove the existing power supply from your computer case and replace it with the Coolmax power supply.
 - Connect the power Connectors to the motherboard and peripheral drives.
 - Connect the 3-pin fan single connector to one of the fan connectors on your motherboard.
- Note:** You do not need to connector the 3-pin fan signal connector in order to make the power supply work if you choose not to monitor the speed of the fan.
Close the computer case .
Connect the power cord to the Coolmax power supply.

>>> Coolmax Cable Management

Coolmax Cable Management enables you to freely select wiring harnesses as you need. Specific color connectors and infixed socket with sticker design pasted on the power supply unit can assist in the installation. Concurrently, Coolmax Cable Management can lower down confusion inside your PC case for improving air circumrotation.

>>> Coolmax Cable Illustration

Cable Length				
No.	A	B	C	D
(mm)	550	150	450	550

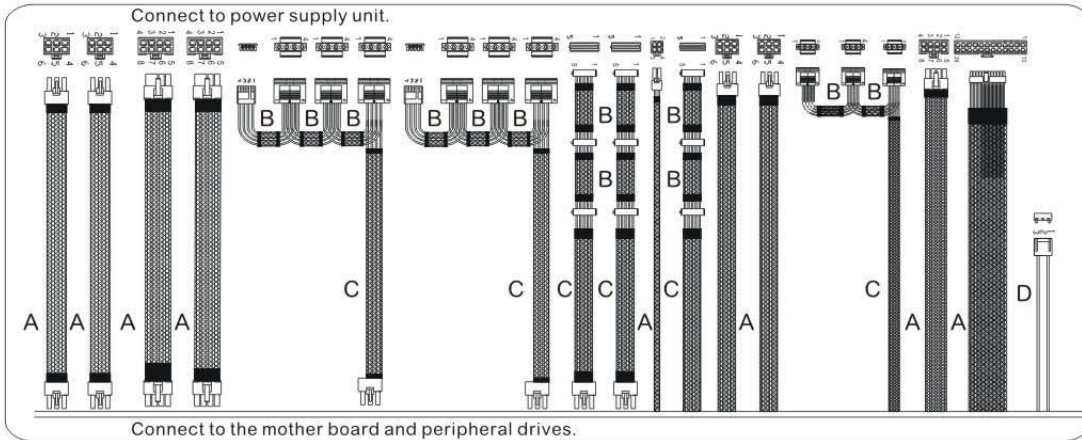

Cable Length				
No.	A	B	C	D
(mm)	550	150	450	550

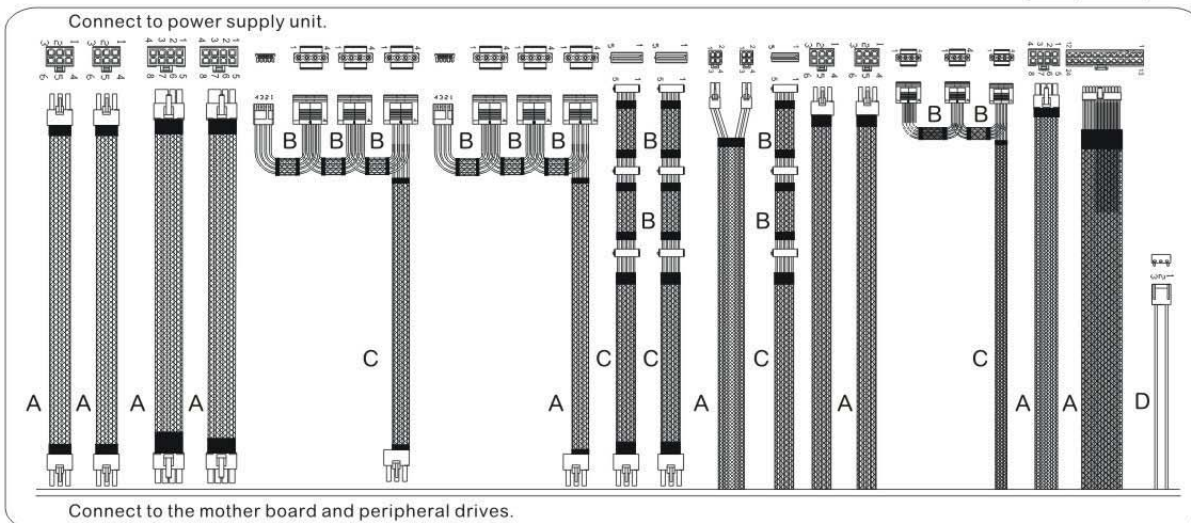

HPC-850/1000/1200-G14C

Upon one side of power supply unit with cable management, you can detect the sets of wires extended from the PSU inside. One set is with one connector for the 3-pin fan signal monitor. Others are with two standard 4-pin peripheral connectors for PC case fan only. Furthermore, you can find the infixed sockets on the side of PSU. Each socket is for each connector. These sets of wires with connectors include:

a. Two sets of wires with a 8-pin PCI-Express graphic card connector at one end and a 8-pin power supply unit red connector at another end.

Qty	2
Connector Color	

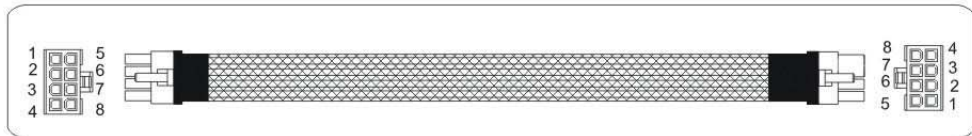

b. Two sets of wires with a 6-pin PCI-Express graphic card connector at one end and a 6-pin power supply unit red connector at another end.

Qty	2
Connector Color	

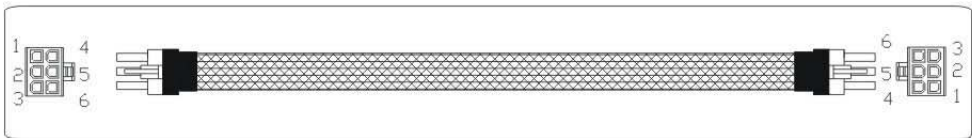

c. Two sets of wires with a 6-pin PSU black connector at one end and three standard 4-pin peripheral and one floppy power connectors at others ends

Qty	2
Connector Color	



d. Two sets of wires with two Serial ATA connectors at the ends and the (6 pin) PSU black connectors at the other end. [Remark] the s-ATA connectors contain the 3.3V output so that you can set latest generation s-ata devices.

Qty	2
Connector Color	

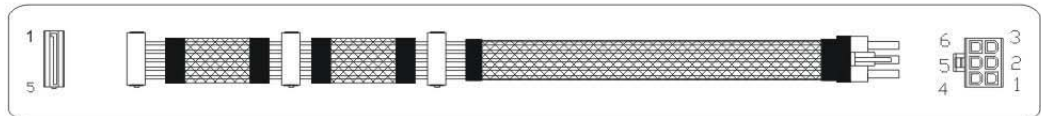

All the right side connectors above are installed to the side of infixed sockets by PSU. Moreover, please refer to the configuration below and correspond the letters to the above a, b, c, d, e, f for install wiring harnesses exactly.

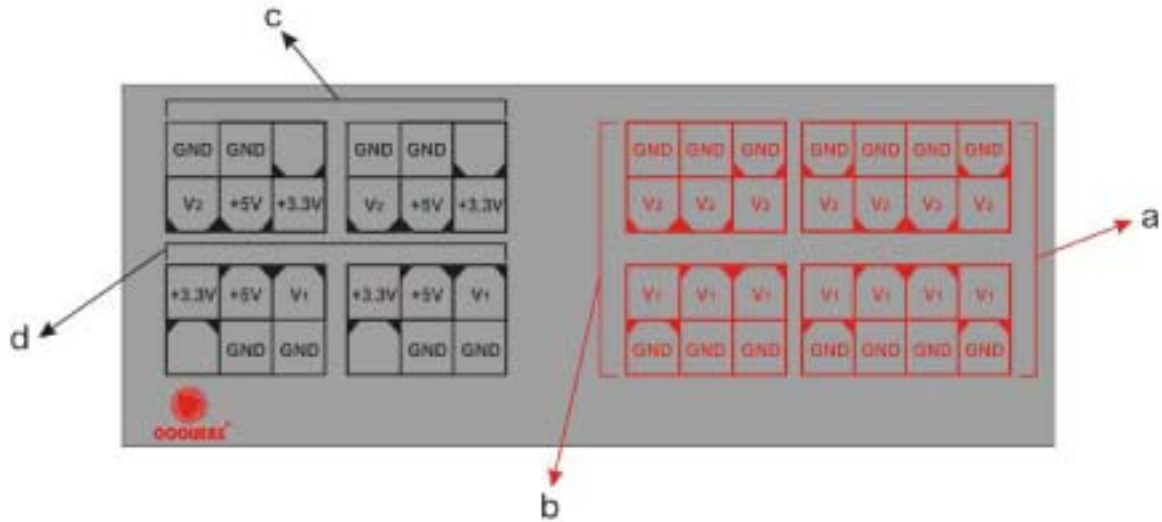

>>> Electric Specification

INPUT	Fan Type	13.5 + 8cm Fan	13.5 + 8cm Fan
	Model	CUQ-1200B	CUQ-1350B
	Voltage	115V~230V	115V~230V
	Frequency	47~63Hz	47~63Hz
	Current	10A	10A
OUTPUT	Efficiency	Typical 80%	Typical 80%
	DC Voltage	DC Current (Min/Max)	DC Current (Min/Max)
	+5V	30A	30A
	+3.3V	24A	24A
	+12V1	18A	19A
	+12V2	18A	19A
	+12V3	18A	19A
	+12V4	18A	19A
	+12V5	19A	19A
	-12V	0.5A	0.5A
	+5vsb	3A	3A
	+5V&+3.3V	190W	190W
	Total Output	1200W	1350W

>>> Physical Dimension

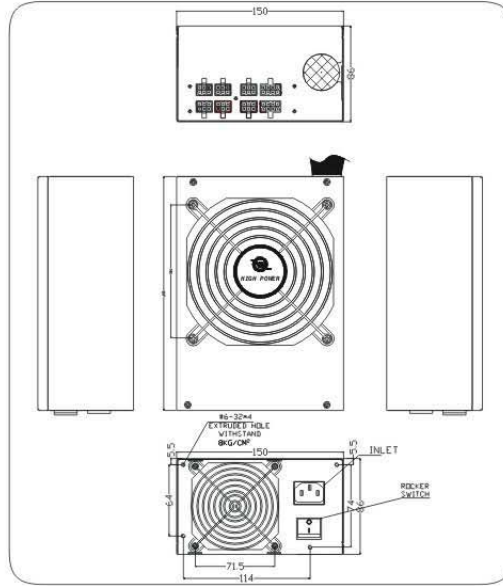

HPC-750/850/1000/1200-G14C

>>> Connectors Description and Illustration

Main Power Connector

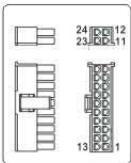

Voltage	Color	Pin	Color	Pin	Voltage
+3.3 V	Orange	1	Orange	13	+3.3 V
+3.3 V	Orange	2	Blue	14	-12 V
COM	Black	3	Black	15	COM
+5 V	Red	4	Green	16	PS_ON#
COM	Black	5	Black	17	COM
+5 V	Red	6	Black	18	COM
COM	Black	7	Black	19	COM
PWR_ON	Gray	8	N/C	20	N/C
+5 V#B	Purple	9	Red	21	+5 V
+12 V	Yellow	10	Red	22	+5 V
+12 V	Yellow	11	Red	23	+5 V
+3.3 V	Orange	12	Black	24	COM

For 750W only

+12V Connector (4+4 pin)

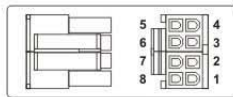

For 850W/1000W/
1200W only

Color	Signal	Pin
Black	COM	1
Black	COM	2
Black	COM	3
Black	COM	4
Yellow	+12VDC	5
Yellow	+12VDC	6
Yellow	+12VDC	7
Yellow	+12VDC	8

8pin VGA

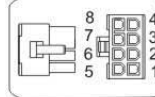

Color	Signal	Pin
Yellow	COM	1
Yellow	COM	2
Yellow	COM	3
Black	COM	4
Black	+12VDC	5
Black	+12VDC	6
Black	+12VDC	7
Black	+12VDC	8

Case Fan Only Connector (4 pin)

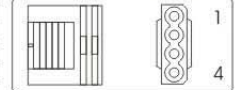

Color	Signal	Pin
Yellow	+12VDC	1
Black	COM	2
		3
		4

PCI Express Connector (6 pin)

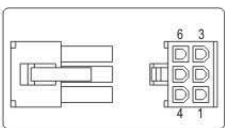

Color	Signal	Pin
Yellow	12VDC	1
Yellow	12VDC	2
Yellow	12VDC	3
Black	COM	4
Black	COM	5
Black	COM	6

Floppy Disk Connector (4 pin)

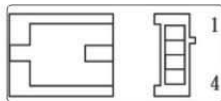

Color	Signal	Pin
Red	+5VDC	1
Black	COM	2
Black	COM	3
Yellow	+12VDC	4

Peripheral Connector (4 pin)

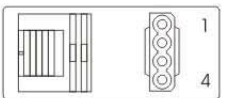

Color	Signal	Pin
Yellow	+12VDC	1
Black	COM	2
Black	COM	3
Red	+5VDC	4

Serial ATA Power Connector

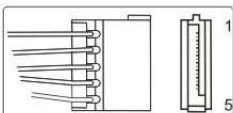

Color	Signal	Pin
Yellow	+12VDC	1
Black	COM	2
Red	+5VDC	3
Black	COM	4
Orange	+3.3 VDC	5

CPU 8pin

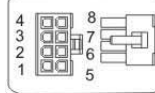

Color	Signal	Pin
Black	COM	1
Black	COM	2
Black	COM	3
Black	COM	4
Yellow	+12VDC	5
Yellow	+12VDC	6
Yellow	+12VDC	7
Yellow	+12VDC	8

Fan Monitor Connector (3 pin)

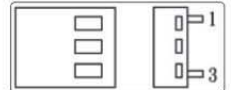

Color	Signal	Pin
Black	COM	1
Yellow	Fan Monitor	3

>>> Product -Related Specification

► **Temperature**

Storage ambient : 0°C~50°C

Operating ambient : -40°C~60°C

► **Humidity**

Storage : 20°C~90°C : Operation : 20%~95%

► **Altitude**

The power supply can operate normally at any attitude between 0~8000 ft

>>> Safety Approval

Coolmax switching power supply has been certified to comply with multiple safety and EMI standards.

► **Safety**



► **EMI**



► **MTBF(Mean Time Between Failure)**

The MTBF of the power supply is calculated by utilizing the quality factors listed in Part-Stree Analysis method of MIL-HDBK-217F.

The calculated MTBF of Coolmax switching power supply is greater than 100,000 hours under the following conditions:

70% full loading, 220VAC/50Hz input, 25°C ambient.

>>> Protection function

All the Coolmax products are designed with comprehensive protection features to safeguard the power supply and system.

Notice

If the power supply latches into shut down stage (when protection function is in effect as defined below), the power supply shall return to normal operation only after the fault has been removed and PS-on has been cycled off/on for a minimum of time for 1 second or remove AC power from the power supply then re-applied.

► **Over/Under Voltage Protection(OVP/UVP)**

When the output voltage exceeds the spec defined below, the power supply shall be latched into the status of shutdown.

DC OUTPUT	UVP (Min)	OVP(Max)
+5V	3.9V	7.0V
+3.3V	2.8V	4.3V
+12V	8.0V	15.6V

► **Over Current Protection(OCP)**

Overload current applied to each tested output rail will cause output trip before they reach or exceed 110% ~ 150% for testing purposes. Over load current shall be ramped at a minimum rate of 10A/s starting from full load.

